

GOTOWE PROJEKTY

WZOROWA ERGONOMIA PRACY

Ergomax Flexible



1049,00

Ergomax Enjoy



819,00

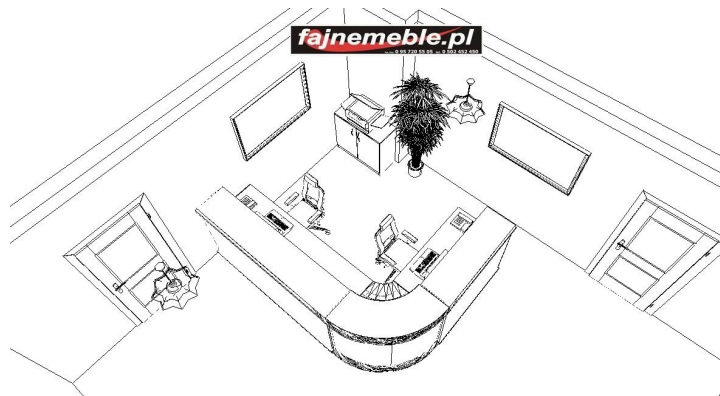

3599,00

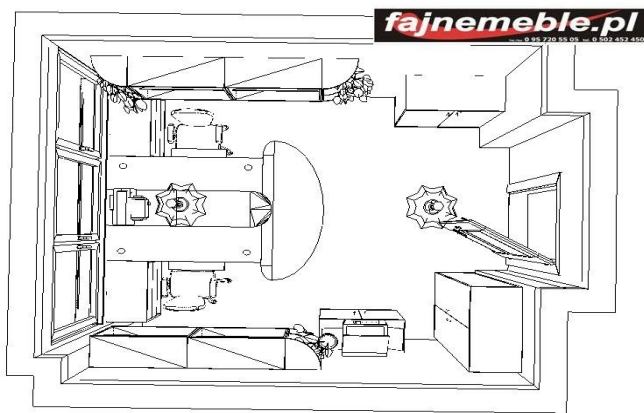

3799,00

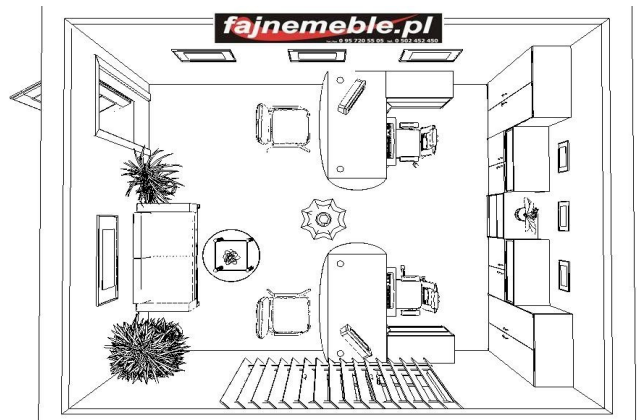

4399,00

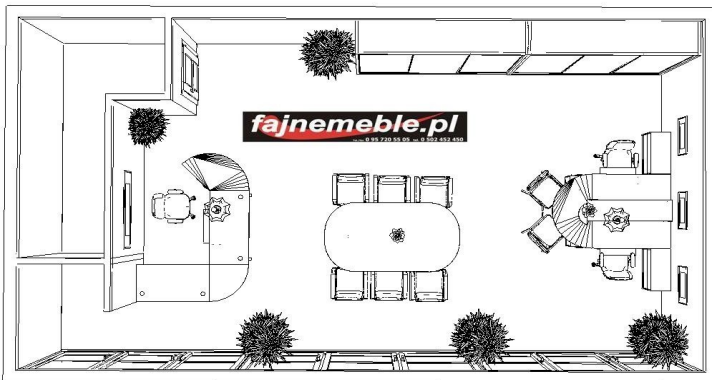

4199,00

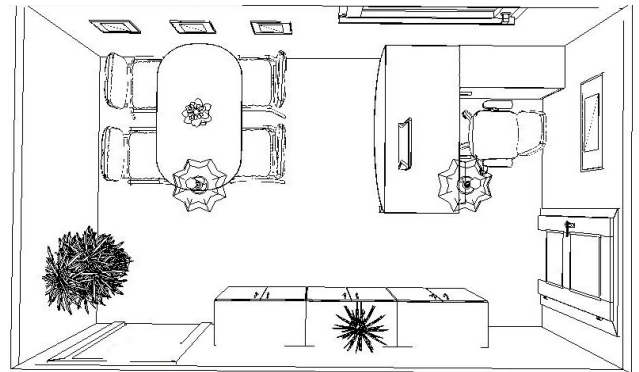

2699,00

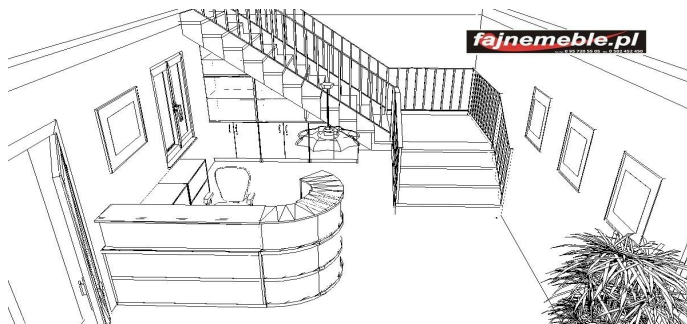

4799,00

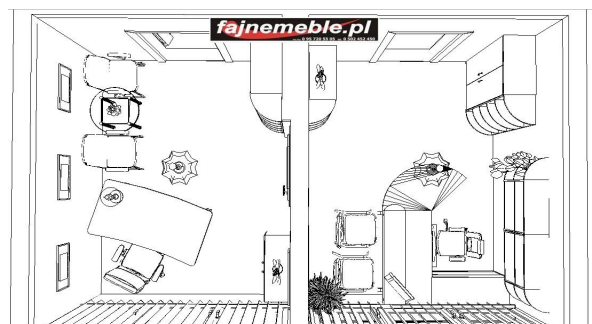

5199,00

...i wiele innych...Dopasujemy się indywidualnie do potrzeb klienta !

(podane ceny są cenami netto)